



BALLAST SPECIFICATION

400W M59

Metal Halide

V90J6414

60 Hz CWA C&C

Input Volts	120	277	347
Line Current (Amps)			
Operating	4.00	1.75	1.40
Open Circuit	2.35	1.10	0.90
Starting	3.50	1.55	1.20
Recommended Fuse (Amps)	10	5	4
Regulation			
Line Volts	±10%	±10%	±10%
Lamp Watts	±10%	±10%	±10%
Temperature Ratings			
Insulation Class	180 (H)	180 (H)	180 (H)
Coil Temperature Code	C	D	D
Benchtop Coil Rise	81.1	88.5	89.4
Power Factor (%) HPF	90	90	90
Input Watts	454 W	454 W	454 W
Efficiency	88.0%	88.0%	88.0%
NOM. Open Circuit Voltage	305	305	305
Input Voltage At Lamp Dropout	60	125	170
Min Ambient Starting Temp	-20°F/-30°C	-20°F/-30°C	-20°F/-30°C
60 HZ TEST PROCEDURES			
High Potential Test (Volts)			
1 Minute	1,700 V	1,700 V	1,700 V
1 Second	2,100 V	2,100 V	2,100 V
Open Circuit Voltage Test (V)	275 - 335	275 - 335	275 - 335
Short Circuit Current Test (A)			
Secondary Current			
Min	3.50	3.50	3.50
Max	4.30	4.30	4.30
Input Current			
Min	2.80	1.20	0.95
Max	4.20	1.85	1.45
CORE and COIL Specifications			
Dimension (A)	2.15 in	2.15 in	2.15 in
Dimension (B)	4.20 in	4.20 in	4.20 in
Weight	10.5 lb's	10.5 lb's	10.5 lb's
Lead Lengths	12 "	12 "	12 "
Capacitor Requirement			
Microfarads	24.0 uf	24.0 uf	24.0 uf
Volts (Min)	360 V	360 V	360 V

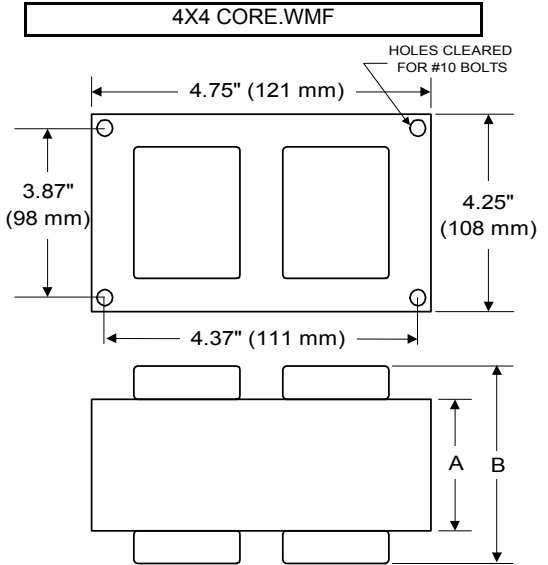

Capacitor: ACB2470V / ACG247 Ignitor: None

Microfarads:	24.0 uf	24.0 uf
Volts (Max):	400 V	400 V
Case Temp (Max):	100 °C	100 °C
Height (Max):	3.25 in	4.67 in
Dia (Max):	1.97 in	1.80 in
Oval Width (Max):	2.97 in	

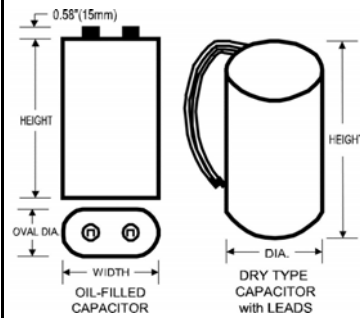

This Ballast Does Not Require An Ignitor

Ordering Information Add Suffix for options
K - Prewired, with Dry Capacitor and Bracket Kit

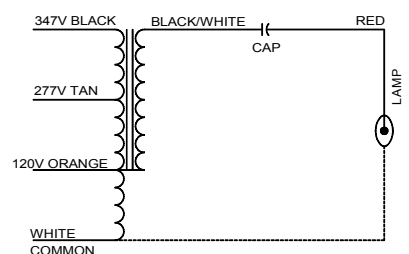

RoHS

Data is based upon tests performed by Venture Lighting in a controlled environment and is representative of relative performance. Actual performance can vary depending on operating conditions. Specifications are subject to change without notice.

5/11/2018 Production Coil Material (PRI/SEC): AI / AI