

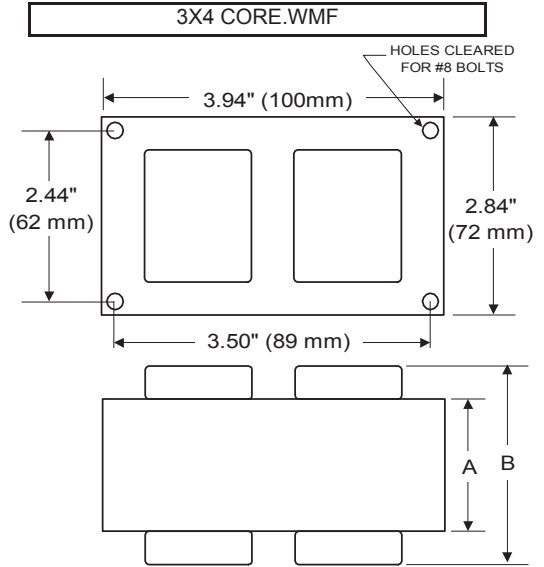

BALLAST SPECIFICATION

100W S54
High Pressure Sodium
V90D1333
60 Hz HX C&C

Input Volts	120	208	240	277
Line Current (Amps)				
Operating	1.10	0.60	0.55	0.45
Open Circuit	2.10	1.20	1.05	0.90
Starting	0.90	0.55	0.45	0.40
Recommended Fuse (Amps)	6	3	3	3
Regulation				
Line Volts	±5%	±5%	±5%	±5%
Lamp Watts	±10%	±10%	±10%	±10%
Temperature Ratings				
Insulation Class	180 (H)	180 (H)	180 (H)	180 (H)
Coil Temperature Code	A	A	A	A
Benchtop Coil Rise	63.3	60.2	60.8	64.9
Power Factor (%) HPF	90	90	90	90
Input Watts	126 W	126 W	126 W	126 W
Efficiency				
NOM. Open Circuit Voltage	130	130	130	130
Input Voltage At Lamp Dropout	90	160	180	210
Min Ambient Starting Temp	-40°F/-40°C	-40°F/-40°C	-40°F/-40°C	-40°F/-40°C
60 HZ TEST PROCEDURES				
High Potential Test (Volts)				
1 Minute	2,000 V	2,000 V	2,000 V	2,000 V
1 Second	2,500 V	2,500 V	2,500 V	2,500 V
Open Circuit Voltage Test (V)	115 - 145	115 - 145	115 - 145	115 - 145
Short Circuit Current Test (A)				
Secondary Current				
Min	2.50	2.50	2.50	2.50
Max	3.00	3.00	3.00	3.00
Input Current				
Min	0.70	0.40	0.35	0.30
Max	1.00	0.60	0.50	0.45
CORE and COIL Specifications				
Dimension (A)	2.00 in	2.00 in	2.00 in	2.00 in
Dimension (B)	3.45 in	3.45 in	3.45 in	3.45 in
Weight	5.9 lb's	5.9 lb's	5.9 lb's	5.9 lb's
Lead Lengths	12 "	12 "	12 "	12 "
Capacitor Requirement				
Microfarads	10.0 uf	10.0 uf	10.0 uf	10.0 uf
Volts (Min)	280 V	280 V	280 V	280 V



Capacitor:	ACG308	Ignitor:	BVS-006-A
Microfarads:	10.0 uf	Case Temp (Max):	105 °C
Volts (Max):	330 V	BTL Distance (Max)	5 ft
Case Temp (Max)	100 °C		
Height (Max):	2.76 in		
Dia (Max):	1.61 in		
Oval Width (Max):			

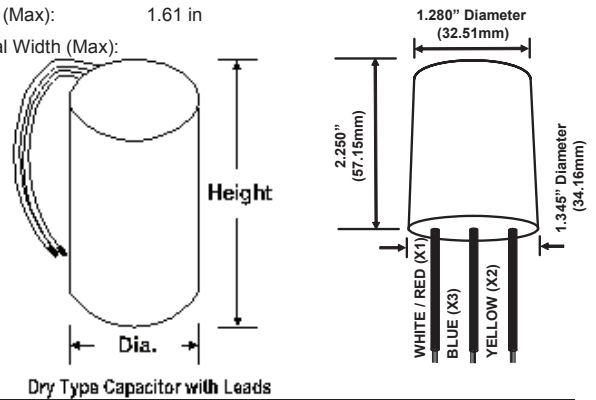

Ordering Information Add Suffix for options
 C - With Dry Capacitor
 CB - With Dry Capacitor and Welded Bracket
 B - With Welded Bracket, no Capacitor
 K - Prewired, with Dry Capacitor and Bracket Kit

Data is based upon tests performed by Venture Lighting in a controlled environment and is representative of relative performance. Actual performance can vary depending on operating conditions. Specifications are subject to change without notice.

04/22/2020 **Production** Coil Material (PRI/SEC): Cu / Al



RoHS

