

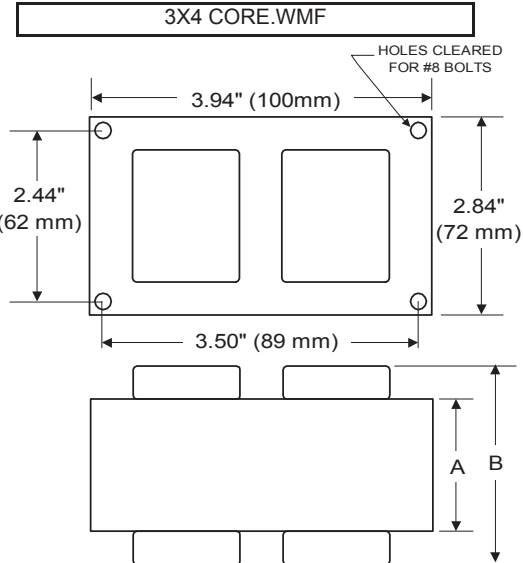

BALLAST SPECIFICATION

150W S55
High Pressure Sodium
V90V1454T
60 Hz CWI C&C

Input Volts	347				
Line Current (Amps)					
Operating	0.60				
Open Circuit	0.25				
Starting	0.30				
Recommended Fuse (Amps)	2				
Regulation					
Line Volts	±10%				
Lamp Watts	±10%				
Temperature Ratings					
Insulation Class	180 (H)				
Coil Temperature Code	B				
Benchtop Coil Rise					
Power Factor (%) HPF	90				
Input Watts	186 W				
Efficiency					
NOM. Open Circuit Voltage	120				
Input Voltage At Lamp Dropout	260				
Min Ambient Starting Temp	-40°F/-40°C				
60 HZ TEST PROCEDURES					
High Potential Test (Volts)					
1 Minute	1,700 V				
1 Second	2,000 V				
Open Circuit Voltage Test (V)	110 - 130				
Short Circuit Current Test (A)					
Secondary Current	Min 3.90				
Max 4.80					
Input Current	Min 0.20				
Max 0.40					
CORE and COIL Specifications					
Dimension (A)	3.15 in				
Dimension (B)	4.55 in				
Weight	11.0 lb's				
Lead Lengths	12 "				
Capacitor Requirement					
Microfarads	51.0 uf				
Volts (Min)	280 V				



Capacitor:	ACG240	Ignitor:	BVS-006
Microfarads:	51.0 uf	Case Temp (Max):	105 °C
Volts (Max):	280 V	BTL Distance (Max)	12 ft
Case Temp (Max)	100 °C		
Height (Max):	4.80 in		
Dia (Max):	1.80 in		
Oval Width (Max):			

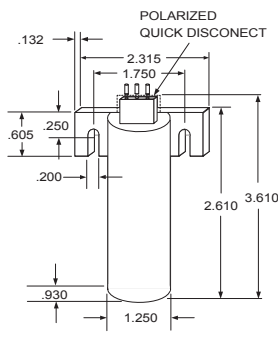
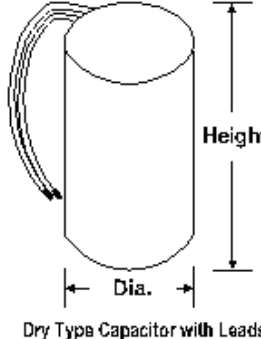

Dry Type Capacitor with Leads

Ordering Information Add Suffix for options
 C - With Dry Capacitor
 CB - With Dry Capacitor and Welded Bracket
 B - With Welded Bracket, no Capacitor
 K - Prewired, with Dry Capacitor and Bracket Kit

Data is based upon tests performed by Venture Lighting in a controlled environment and is representative of relative performance. Actual performance can vary depending on operating conditions. Specifications are subject to change without notice.

04/23/2020 **Production** Coil Material (PRI/SEC): Cu / Cu



RoHS

